

GReddy®

GReddy Turbo Kit

Acura Integra GSR DC2 (B18C) TD-05H 18G



Acura Integra GSR DC2 (B18C) TD-05H 18G

Installation Manual

Please read the entire manual before installing this kit.

Application:

Make	Model	Chassis	Year
Acura	Integra GSR	DC2	96~99

- This **GReddy TD05H 18G Turbo Kit** is designed only for the vehicles specified above.
- **GReddy Front mount intercooler kit** is recommended with this kit
- Premium grade gasoline (92 octane or higher) is required with this Kit.
- Make sure that the vehicle is not equipped with any ECU upgrade chips.
- Use of **GReddy Racing Spark Plugs ISO #7** or NGK plugs (colder than factory) is recommended with this kit.

1. Parts List

1.	Turbocharger TD05H-18G 8cm2 P565	1
2.	Turbo Exhaust Manifold (Cast Iron)	1
3.	Down Pipe Adapter (Cast Iron)	1
4.	Down Pipe (Steel 50Ø)	1
5.	Suction Pipe (Aluminum Elbow No. 10 80Ø 30R 90°)	1
6.	" (Steel 80Ø)	1
7.	Compression Pipe (Steel 50Ø)	1
8.	" (Steel 60Ø)	1
9.	Airinx Air Filter AX-S	1
10.	Airinx Adapter (INX-01024)	1
11.	Injector (310cc)	4
12.	" Seal Ring	4
13.	" Connector Harness	4
14.	Fuel Control Unit	1
15.	Oil Pressure Line (1200mm)	1
16.	" Banjo Union	1
17.	" Copper Washers 10Ø (t=1.0mm)	2
18.	" Three Way Fitting 1/8 NPT	1
19.	" Straight Union Fitting 1/8 PT – 1/8 PT	1
20.	" Straight Union Fitting 1/8 PT – 1/8 PF	1
21.	Oil Return Flange Tube (Turbo Side) 16Ø	1
22.	" Flange Tube (Engine Side) 16Ø	1
23.	" Flange	1
24.	Vacuum Hose (blue) 5Ø X 1300mm (actuator Pressure Line)	1
25.	Rubber Hose 8Ø X 450mm (water by-pass hose)	1
26.	Rubber Hose 10Ø X 510mm (Blow-by hose)	1
27.	Rubber Hose 16Ø X 380mm (Oil Return Hose)	1

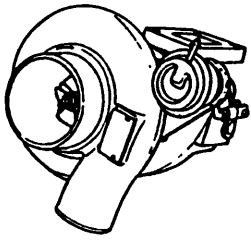

1



2



3

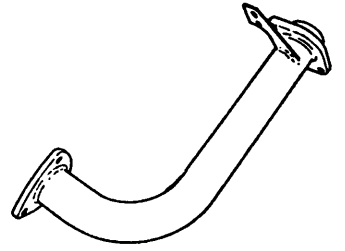

4



5

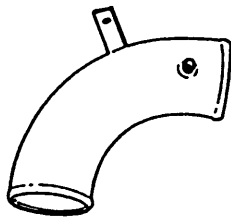

6

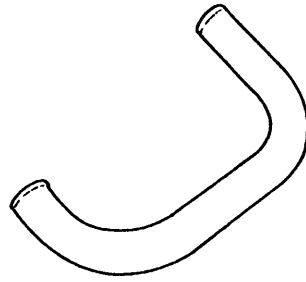

7

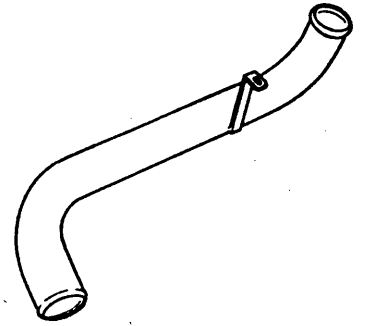

8

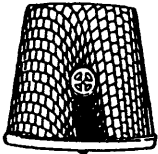

9



10

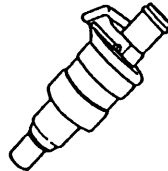

11

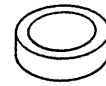

12

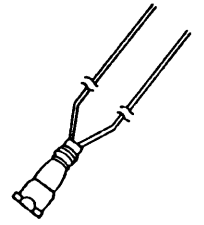

13

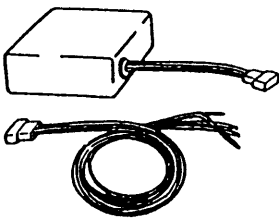

14

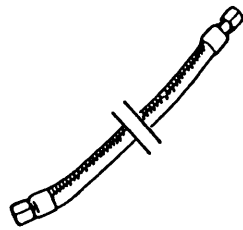

15



16



17



18

1. Parts List

28.	Rubber Hose	50Ø X 70mm	1
29.	Rubber Hose	80Ø X 60mm	1
30.	Rubber Hose	80Ø X 80mm	2
31.	Reducer Hose	50Ø – 60Ø	1
32.	Reducer Hose	60Ø – 65Ø	1
33.	Hose band	8Ø Tridon #4	2
34.	Hose band	10Ø Tridon #5	2
35.	Hose band	16Ø Tridon #10	2
36.	Hose band	50Ø Tridon #32	3
37.	Hose band	60Ø Tridon #36	2
38.	Hose band	65Ø Tridon #40	1
39.	Hose band	80Ø Tridon #48	6
40.	Gasket Turbo in		1
41.	Gasket Turbo out		1
42.	Gasket Down Pipe Adapter	60Ø triangle	1
43.	Gasket Down Pipe	50Ø ring	1
44.	Gasket Oil Return Flange Tube		2
45.	A/C line Bracket		1
46.	Heat shield Turbo Manifold		1
47.	Thermo-cloth	100mm X 1000mm sheet	1
48.	Zip ties	150mm	10
49.	Three-way Vacuum Tee		1
50.	M6 X 15 P=1.0	B S/W F/W - (Oil Return – A/C Bracket – Heat Shield)	8
51.	M6 X 15 P=1.0	B S/W F/W N (A/C Bracket)	1
52.	M8 X 30 P=1.25	B S/W - N (Exhaust manifold – Turbo in flange)	6
53.	M8 X 35 P=1.25	B S/W F/W - (Oil Return – A/C Bracket – Heat Shield)	5
54.	M10 X 25 P=1.5	B S/W F/W - (Down pipe)	3



19, 20



21



22



23

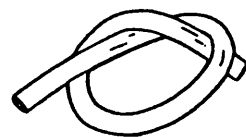

24~27

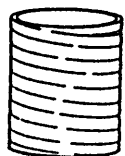

28~30



31, 32

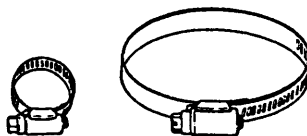

33~39



40

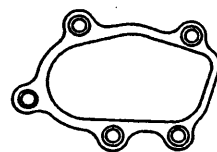

41

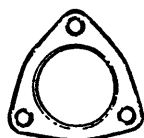

42



43



44

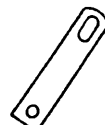

45

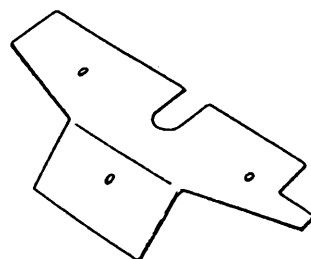

46

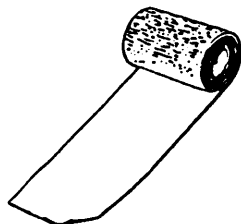

47



48

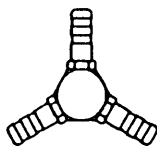

49

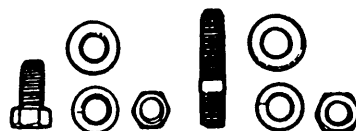

50~54

2. Removal of Stock Parts

When removing the stock parts, make sure you read over the factory repair manual for proper procedures.

- 2-1 Disconnect the negative side of the battery, and remove the undercover.
- 2-2 Drain the engine oil and coolant.
- 2-3 Remove the air cleaner box with all the brackets, air intake tube, and breather/water pipe.
- 2-4 Remove the O₂ Sensor and the exhaust manifold.
- 2-5 Remove the lower trans. cover and the oil pan.
- 2-6 Remove the A/C condenser fan and the radiator fan.
- 2-7 Disconnect the upper and the lower radiator hose, then remove the radiator.

3. Kit Installation

3-1 Oil Pan Modification

- (1) Drill three holes to the oil pan that was removed, and install the oil return flange tube. Install the oil return flange so that the pipe points to the transmission side of the pan.
(See the illustrations)

- * Apply some sealant to the oil return flange tube mounting bolts.

CAUTION

When cutting, grinding, or drilling, make sure you wear a safety glasses, or a facemask for protection.

(Parts used #22, 23, 44, 50)

- (2) Reinstall the modified oil pan back on to the engine block.

- * Use a new oil pan gasket.
- * Be sure to clean the oil pan thoroughly before reinstallation.

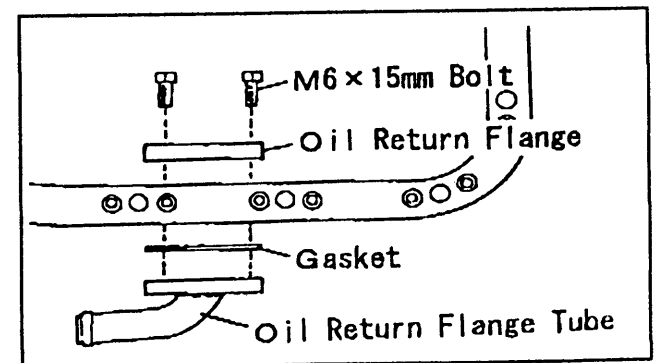
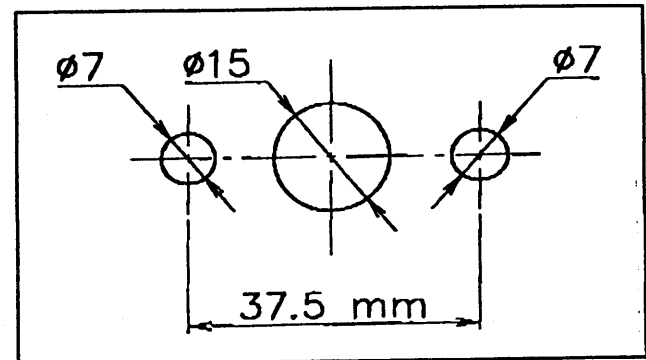
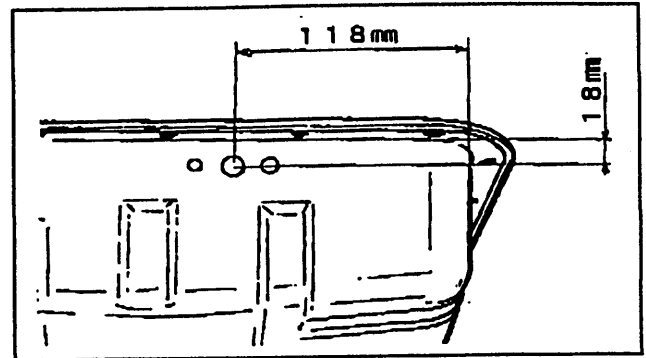

3-2 Thermo-cloth Installation

Wrap the A/C line with the provided Thermo-cloth as shown.

CAUTION

Make sure to use the thermo-cloth properly to prevent damage and fire.

(Parts used #47)

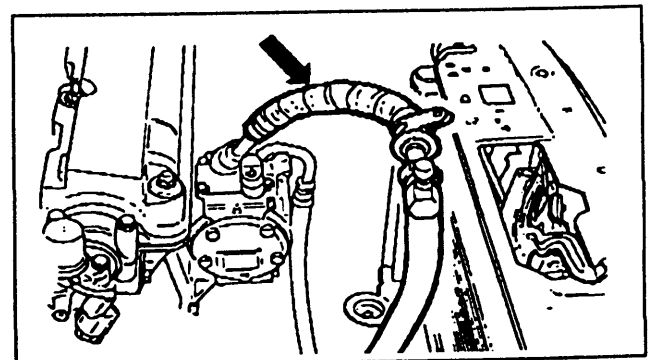

3-3 Throttle Body Water Line Installation
Install the water by-pass hose from the water by-pass tube to the throttle body.
(Parts used #25, 33)

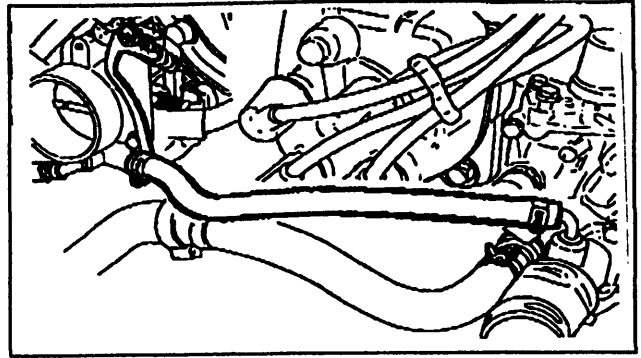

3-4 Turbocharger Assembly

- (1) Install the oil return flange tube to the turbocharger using the provided gasket.
(Parts used #1, 21, 44, 50)

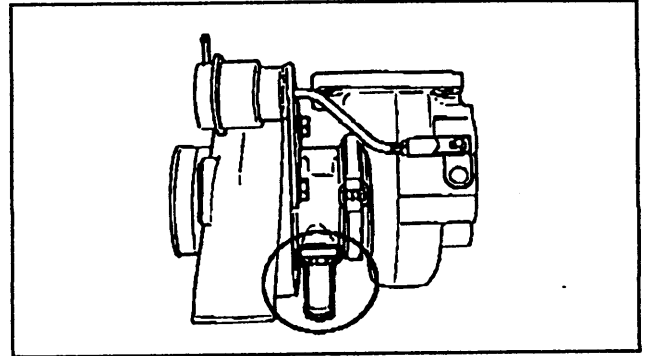

- (2) Install the provided stud bolts on to the turbo manifold and mount the turbocharger to the manifold using the provided gasket.
(Parts used #2, 40, 52)

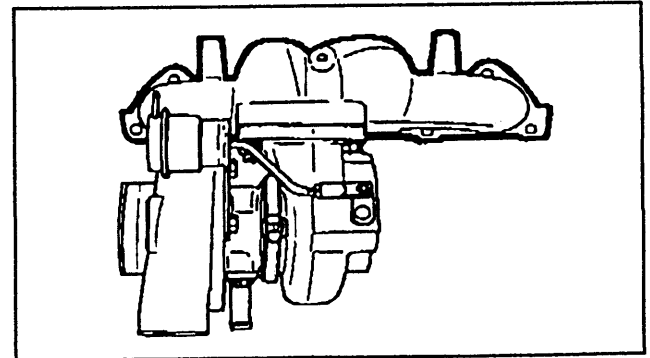

- (3) Install the provided oil pressure line to the turbocharger.
① Install the female banjo union to one end of the oil pressure line.
(Parts used #15,16)

* It is impossible to tighten the banjo union after it is installed on to the turbo, so make sure it is installed tight.

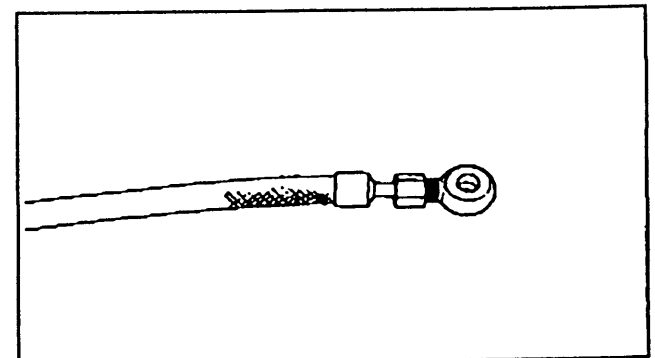

② Install the oil pressure line to the turbocharger using banjo union fitting, and copper washers.
(Parts used #17)

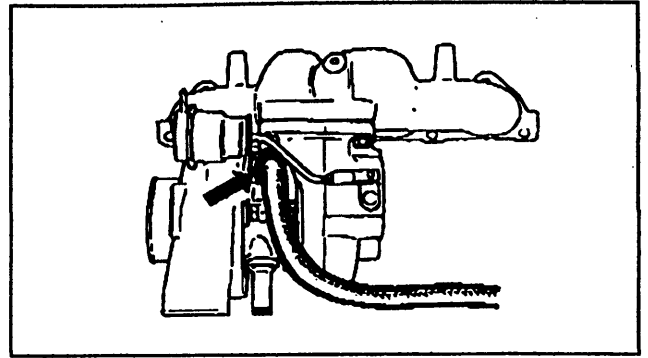

(4) Install stud bolts to the turbine housing and install the down pipe adapter with provided gasket.
(Parts used #3,41,53)

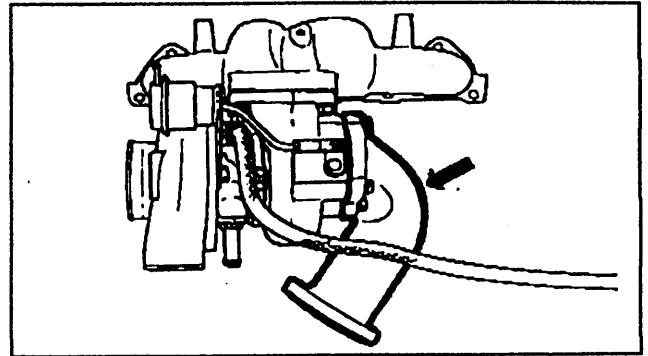

3-5 Turbocharger Assembly Installation

(1) Install 2 stud bolts to the two center holes above the exhaust ports as shown.

* (Parts used #52)

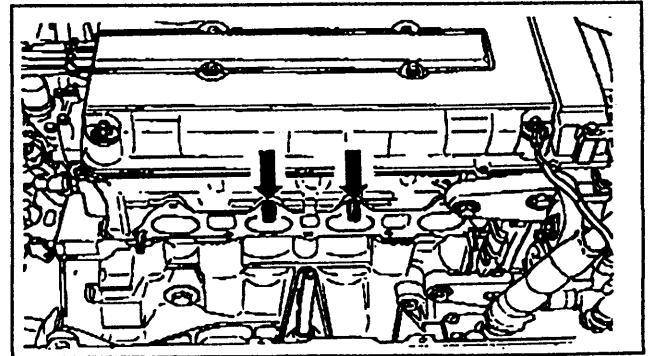

(2) Push the oil level gauge guide tube back slightly to avoid contact with the turbocharger assembly, then install the turbocharger assembly.

* Use 5 stock bolt for the manifold, and factory exhaust gasket.

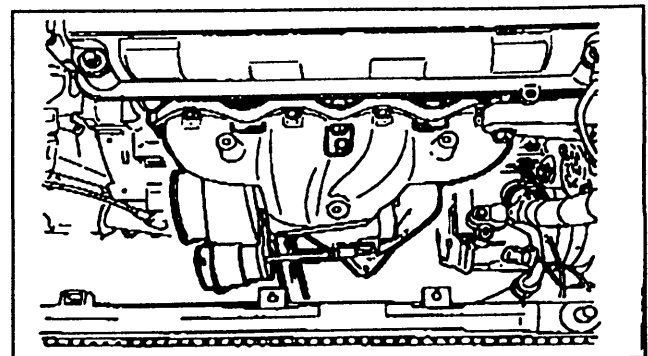

3-6 Radiator Installation

- (1) Slot out the hole on the upper radiator bracket, then position the radiator as far forward as possible.
- (2) Reinstall the A/C condenser fan.

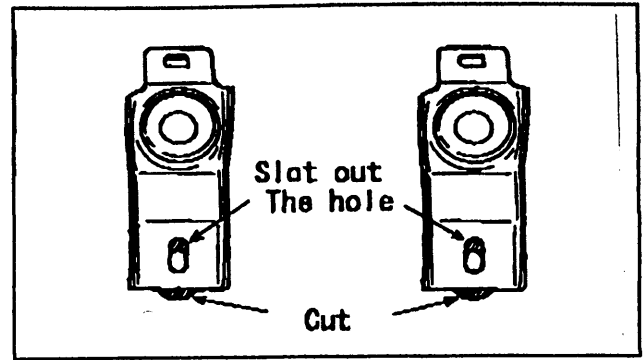

- (3) Trim small part off the radiator fan to avoid it from contacting the turbocharger, then install the fan and connect the radiator hoses.

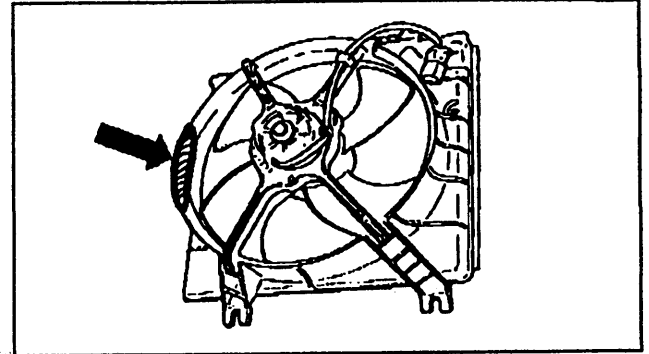

CAUTION

When cutting, grinding, or drilling, make sure you wear a safety glasses, or a facemask for protection.

3-7 Oil Return Connection

Cut the provided 16Ø hose to a length of 280mm, then connect the turbo oil return to the oil pan.

- * Wrap the oil return hose with the provided thermo-cloth.
(Parts used #27, 35, 47)

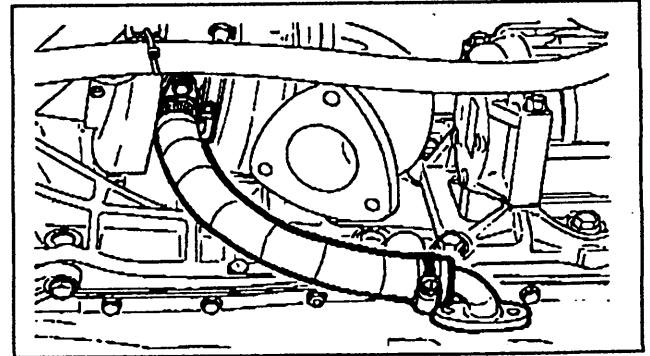

3-8 Oil Pressure Line Connection

- (1) Remove the factory oil pressure switch located on the left side of the oil filter, then install the oil pressure union and the three way fitting as shown.
(Parts used #18, 19, 20)

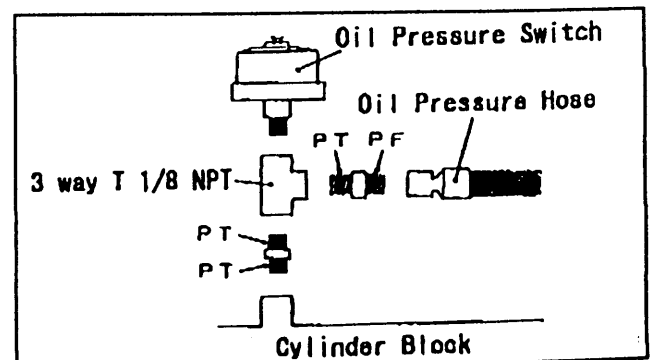

- (2) Connect the oil pressure line from the turbo to the three way fitting.
- * Route the oil pressure line to the back of the engine along with the power steering line. (Pulley side of the engine)
Make sure that the line will not rub up on the actuator rod, by securing it on to the A/C condenser fan frame as shown. (Wrap the line with 16Ø hose before securing it to the fan.)
 - * Apply some Teflon tape to the PT side of the union fitting. (Parts used #27, 48)

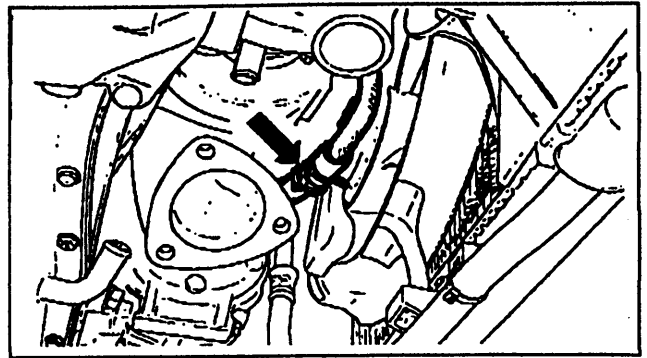

CAUTION

Improper connection of the oil pressure line can damage the turbocharger. When applying Teflon tape, make sure not to get it in side the line. Only on the threads.

CAUTION

If the oil pressure line rubs up on the actuator rod, it will interfere with actuator operation and can damage the engine.

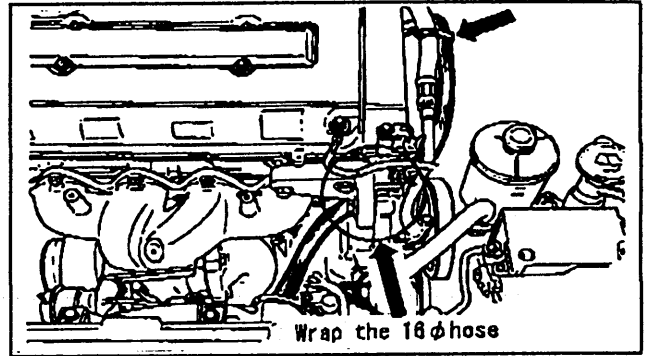

3-9 Compression Pipe Installation

- (1) Bend the two A/C tube over to the left side of the engine bay. Make sure not to crush or kink the tube.

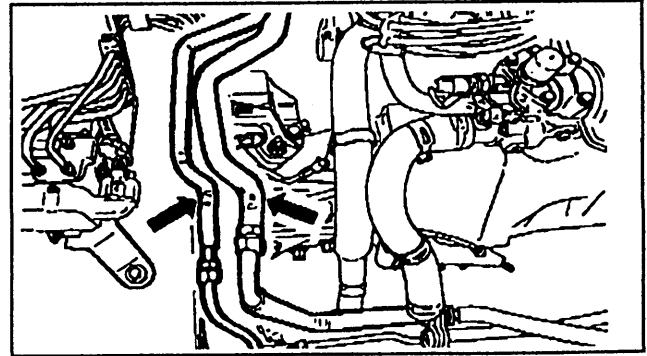

- (2) Remove the harness clamp bracket on the top of the starter motor.

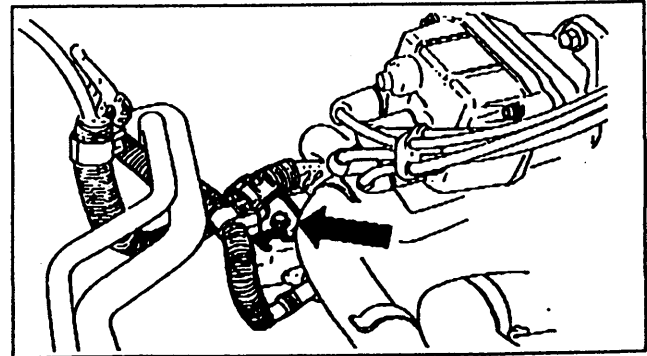

(3) Install the Compression pipe C-1 and C-2 between the turbo and the throttle body.

* Connect the side with a weld on the C-1 pipe to the turbo out let.
(Parts used #7,8,28,31,32,36,37,38)

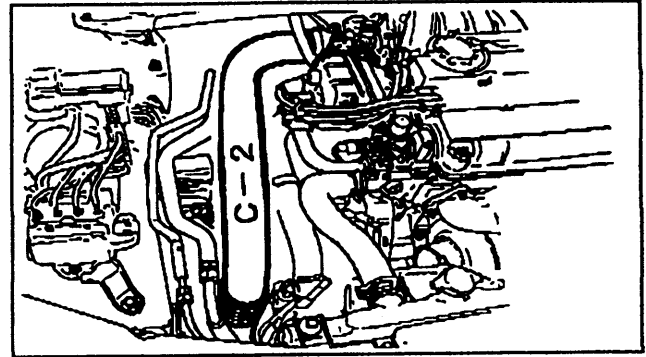
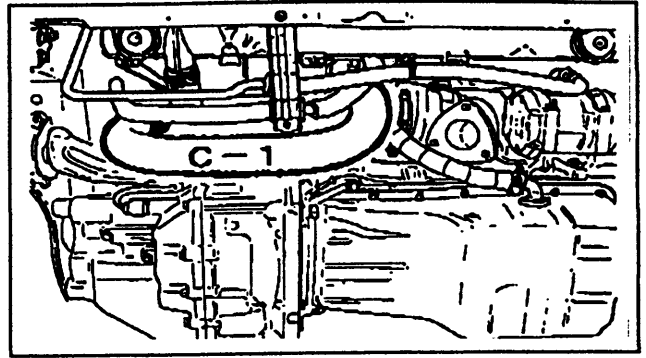

(4) Secure the compression pipe C-2 bracket to the lower radiator hose clamp base plate. Bolt it down with factory bolt next to the transmission ground wire.

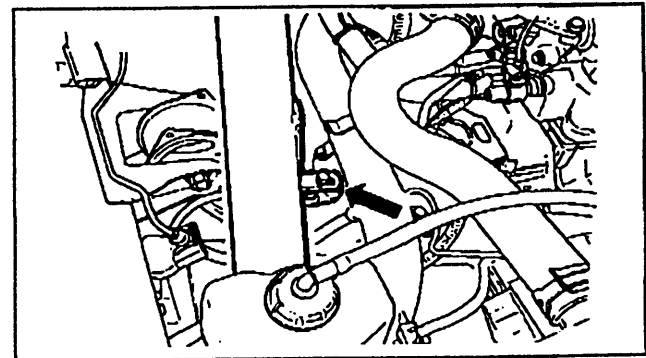

(5) To avoid the A/C line at the bottom of the vehicle from rubbing up on compression pipe C-1, secure it to lower part of the radiator with a zip Tie.
(Parts used #48)

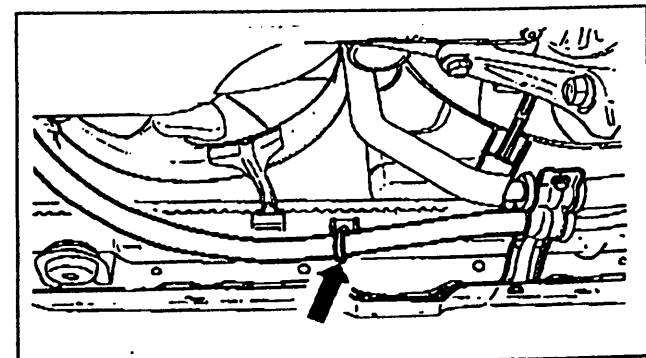

3-10 Intake Pipe Installation

- (1) Remove the VTEC Spool Valve Connector harness bracket. Secure the harness down with a zip tie.
(Parts used #48)

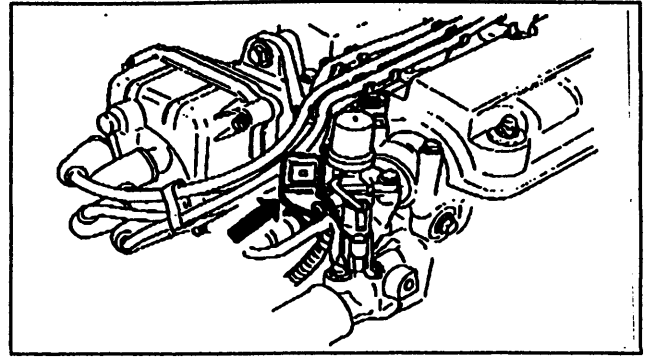

- (2) Mount the Airinx adapter to the Airinx air filter using the provided 6mm cap bolt.
(Parts used #9, 10)

- (3) Install the Airinx, Suction pipe S-1, and S-2 to the inlet of the turbo. Secure the S-2 bracket to the VTEC Spool Valve base.

- * Push down and back the clutch line tube to avoid contact with the suction pipe.
- * Use the 80Ø X 60mm hose (Part # 29) between Airinx and S-2.
(Parts used #5, 6, 29, 30, 39)

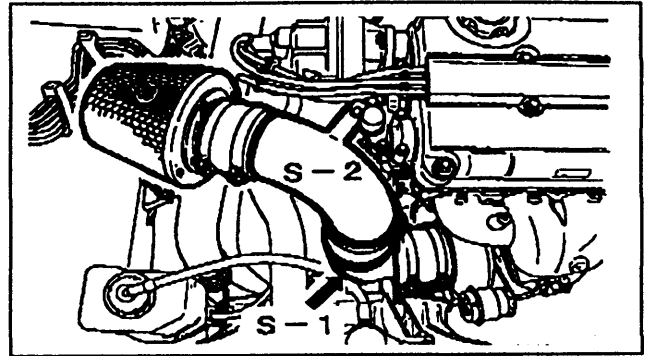

- (4) Connect the 10Ø blow-by hose from the valve cover to the suction pipe S-2. Route the hose under the distributor.
(Parts used #26, 34)

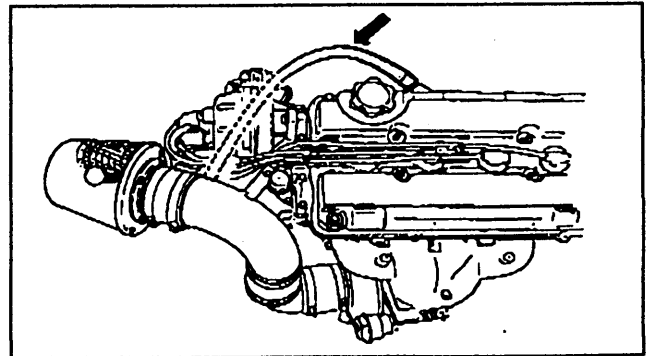

3-11 Down Pipe Installation

Install the down pipe with the provided gaskets.

- * Reuse the factory hardware at the catalytic converter and the down pipe bracket.
(Parts used #4, 42, 43, 54)

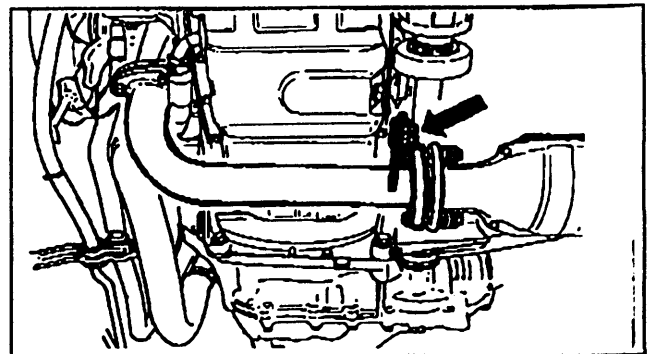

- 3-12 A/C Line Bracket Installation**
Bend the A/C line to avoid the wastegate actuator, radiator fan, and the A/C condenser fan. Secure it with the provided bracket.
(Parts used #45, 50, 51)

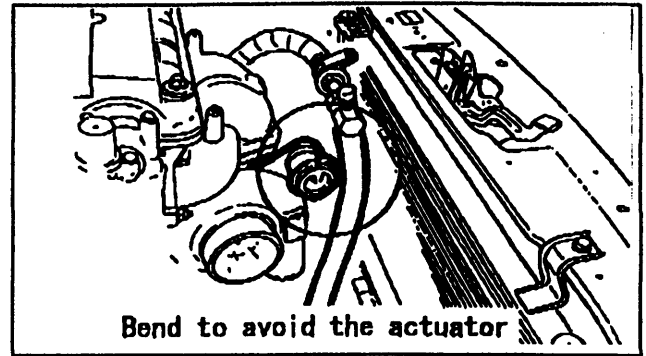

- * When bending the A/C tube, make sure not to crush or kink.

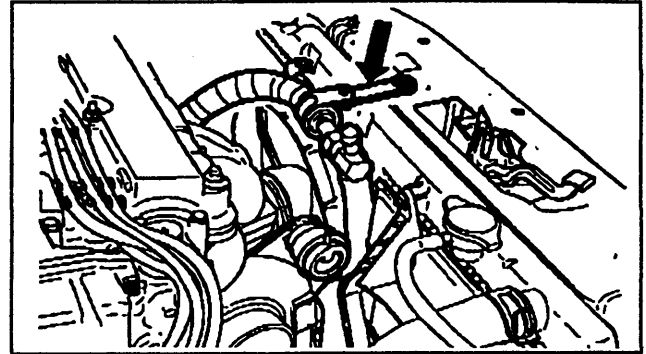

- 3-13 Heat Shield Installation**
Reinstall the oil level gauge, then install the heat shield.

CAUTION
The exhaust manifold gets extremely hot! Without the heat shield, it can damage the vehicle or even cause fire in the engine room. Make sure you use the provided heat shield.

(Parts used #46, 50)

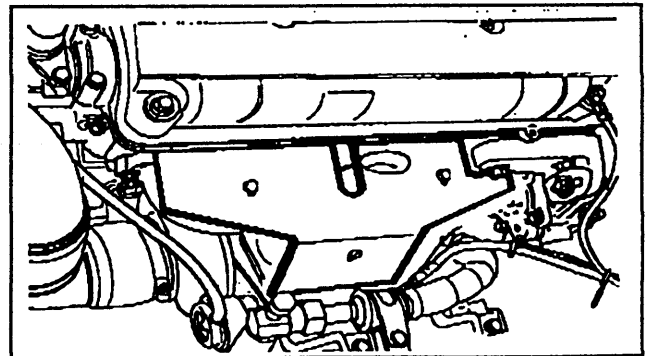

- 3-14 Actuator Vacuum Line Installation**
Share the vacuum port on the back of the intake manifold using the three way vacuum tee, and connect the provided vacuum hose between the three way tee and the actuator.

- * Secure the vacuum hose so that it will not rub up on the radiator fan.
(Parts used #24, 48, 49)

3-14 Upgrade Injector Installation

Replace the Factory Injectors, Injector seal rings, and the connectors with the provided upgrade Injectors, Injector seal rings, and connectors. The + (positive) and - (negative) terminals of the upgrade injectors are on the same sides as the factory injectors.

(Parts used #11, 12, 13)

Important

Make sure to solder all injector wires carefully and use electrical tape or shrink wrap to insulate the wire connections.

3-15 Fuel control unit Installation

(1) Remove the factory ECU located by the passenger side floor. Wire the Fuel Control Unit to the ECU as shown in the diagram below.

(Parts used #14)

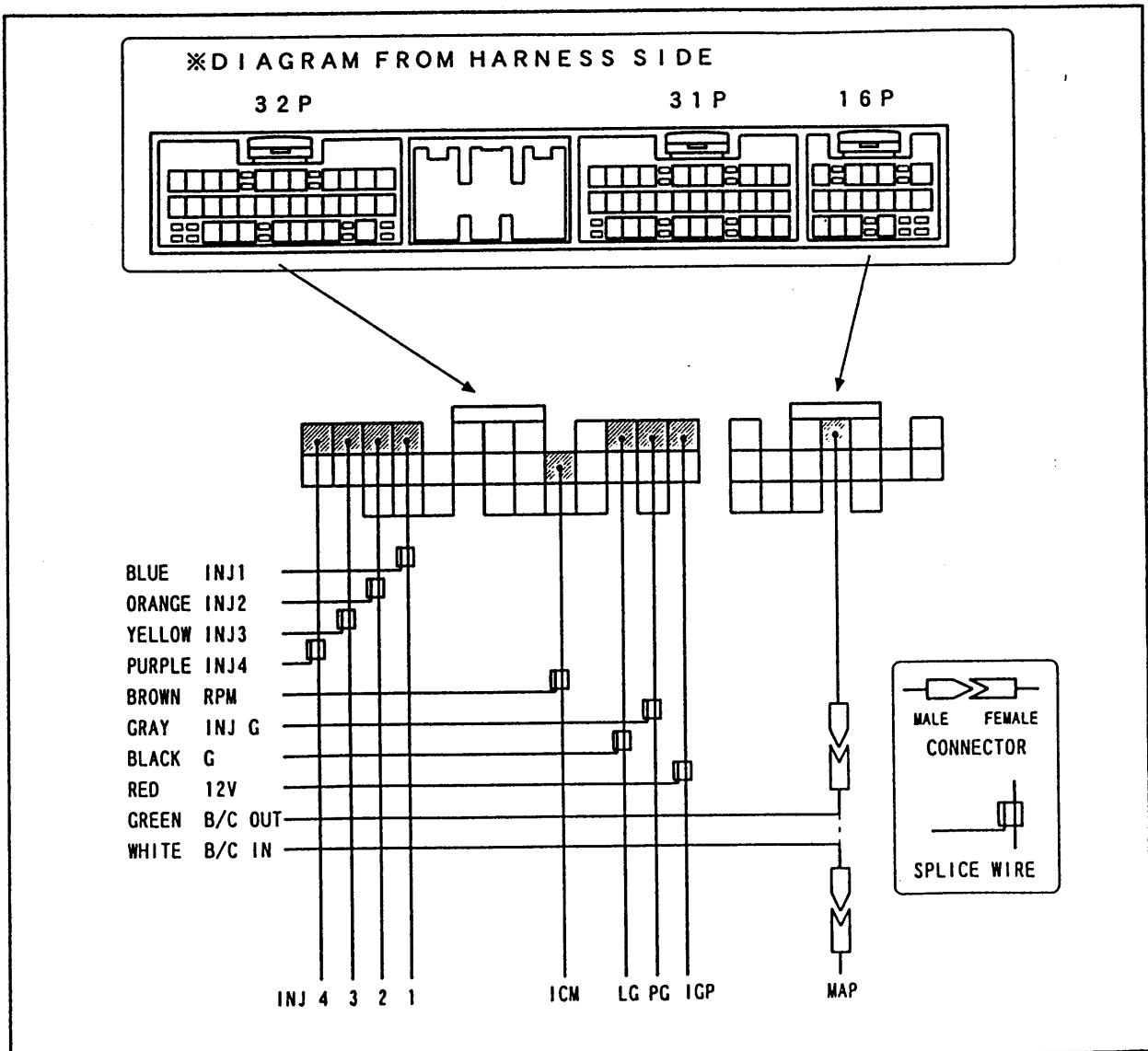

*Only use the provided taps or solder to connect the wires.

(2) Reinstall the ECU back in its place, and secure the Fuel Control Unit next to the ECU.

4. Turbo kit Performance Data

- This kit's boost pressure is preset, and should be below 0.55kg/cm² (7.8 psi)
- The power out put for this kit is show in the graph below.

* **IMPORTANT** The power output will vary at different temperature, atmospheric pressure, and test condition. Use this data as a reference only.

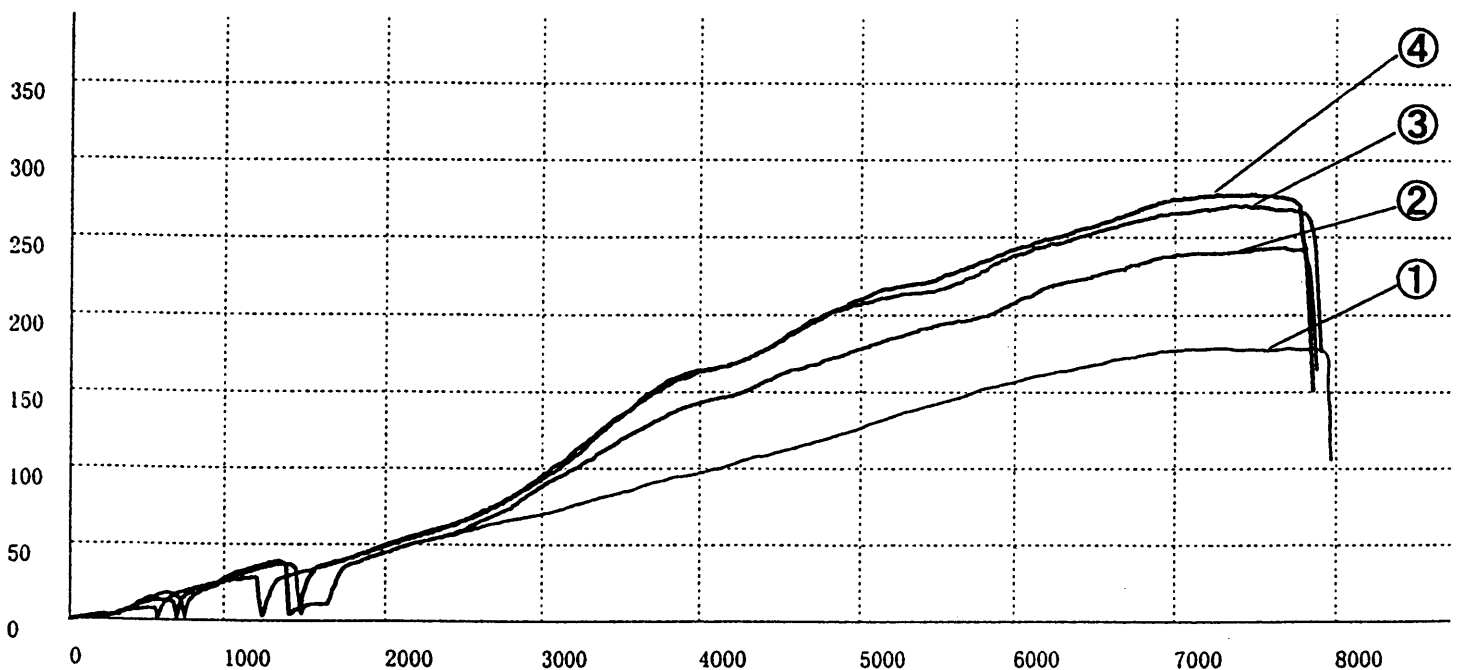

①	Completely Stock		168.0hp
②	TD05H-18G Turbo Kit	Boost 0.55kg/cm ² (7.8psi)	235.2hp
③	② + Type 31 I/C Kit	Boost 0.60kg/cm ² (8.5psi)	261.4hp
④	② + Type 24 I/C Kit	Boost 0.60kg/cm ² (8.5psi)	270.3hp

3-16 Starting the Engine

- (1) Refill the coolant to factory spec.
- (2) Refill the engine oil to factory spec.
- (3) Check all the hoses and wires connection, then reconnect the negative side of the battery.
- (4) Disconnect the distributor harness to crank the engine to get oil pressure to the turbo. Check for any oil leaks, then reconnect the distributor and start the engine.
- (5) While idling, check for any oil, coolant, or air leaks.
- (6) After inspection, reinstall the under cover and other stock parts that was removed.
- (7) On the initial run, be sure to have a boost gauge to check the turbo-actuator setting. This turbo kit is preset to boost between 0.6kg/cm^2 to 0.5kg/cm^2 . It is very important that you monitor the boost pressure, and make sure not to over boost. Over boosting can cause engine damage.

This completes the Turbo Kit installation.

Important!

GReddy Performance Products, Inc. is not responsible for any engine damage caused by over boosting (increased boost), modified kit, or misuse of the product.

Due to lack of control over proper installation and use of this product, **no warranty** is offered concerning the turbocharger.

GReddy/RC Engineering Injector Installation

1. Remove factory injectors as specified in a Honda factory service manual.
2. Installation of GReddy/RC Injectors:
 - A. Cut factory injector harness to remove factory injector plugs.
 - B. Install provided RC Engineering injector plugs by soldering them to the factory injector wires (*When installing, make sure to connect all the plugs the same with the factory + and – wires corresponding)
 - C. Carefully position RC injectors into the fuel rail making sure that the top O-rings are seated into the rail
 - D. Seat lubricated sealing rings (provided with injectors) into the intake manifold
 - E. Slightly lubricate the injector casings and position injectors onto the intake manifold; Seat the injector/fuel rail assembly into the sealing rings already in the intake manifold making sure that the injectors go in straight
 - F. Loosely affix the three set nuts to hold the fuel rail in place, then alternate tightening until the rail is fully set
 - G. At that point, the injectors should be fully seated into the intake manifold
3. Attach the injector clips to the injectors making sure that all the wires correspond to one another

***Note:** The injectors included in this kit have a larger casing than the factory units (it will be a tight fit), but if you follow these instructions, you should not have any problems with the injectors not seating or sealing properly.

